



ZT483E, ZT485E, ZT488E
ZT489E, ZT490E, ZT491E

Low Power 5V 250kbps/10Mbps RS485E Transceivers



Features

- Meets or exceeds the requirements of ANSI Standard TIA/EIA-485-A and ISO 8482:1987(E) specifications for V_{CC} at $+5V \pm 5\%$
- Low quiescent current – 0.5mA typ., 1mA max.
- Low shutdown current (where applicable) - 0.01 μ A typical, 10 μ A max.
- Guaranteed standard data rate 250kbps or 10Mbps
- True Fail-Safe (Open and Short) Receiver
- Thermal shutdown protection
- -7V to +12V common-mode input voltage range
- Half-Duplex or Full-Duplex configuration
- Allows up to 1 unit load (32 devices) on the same common bus
- Controlled driver output slew rate and receiver input filtering
- Active-high driver enable and active-low receiver enable
- ESD Protection on bus terminals
 $\pm 15kV$ Human Body Model (HBM)
- Drop-in Replacements for MAX483E, MAX485E, MAX488E, MAX489E, MAX490E, MAX491E.
- High fanout driving 1/4 unit load (128 devices) available on ZT485ER Series

General Description

The ZT485E series devices are 5V differential data line transceivers for RS485/RS422 communication that consist of one driver and one receiver with high level of ESD protection. They are designed for balanced transmission lines interface that meet ANSI standard TIA/EIA-485-A and ISO 8482:1987(E) specifications.

The ZT485E series devices spans out with half or full duplex, data rate guaranteed at 250k bit per second or 10Mbps, and allow one unit load that fan out 32 devices sharing a common bus. The I/Os are enhanced-electrostatic discharge (ESD) protected, exceeding $\pm 15kV$ Human Body Model (HBM).

Applications

- RS-422/RS-485 communications
- Utility meters
- Industrial process control
- Building automation
- Level translators
- Transceivers for EMI-sensitive applications
- Routers and HUBs
- Industrial-controlled Local Area Networks
- Industrial PCs, embedded PCs and peripherals

ZT483E/ZT485E

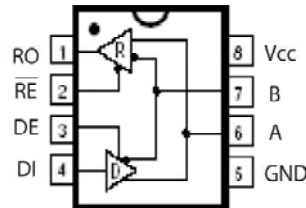

Now Available in Green Package Option

Product Selection Guide And Cross Reference

Part Number	Duplex	# Of Tx/Rx	Data Rate (Mbps)	# of Tx/Rx on Bus	Slew Rate Limit	Rx Input Filtering	Low-Power Shutdown	Tx/Rx Enable	ESD on Tx/Rx	Number of Pins	Pin-to-Pin Cross Reference
ZT483E	Half	1/1	0.25	32	Yes	Yes	Yes	Yes	$\pm 15kV$	8	MAX483E
ZT485E	Half	1/1	10	32	No	No	Yes	Yes	$\pm 15kV$	8	MAX485E
ZT488E	Full	1/1	0.25	32	Yes	Yes	No	No	$\pm 15kV$	8	MAX488E
ZT489E	Full	1/1	0.25	32	Yes	Yes	Yes	Yes	$\pm 15kV$	14	MAX489E
ZT490E	Full	1/1	10	32	No	No	No	No	$\pm 15kV$	8	MAX490E
ZT491E	Full	1/1	10	32	No	No	Yes	Yes	$\pm 15kV$	14	MAX491E



Absolute Maximum Ratings

These are stress ratings only and functional operation of the device at these ratings or any other above those indicated in the operation sections of the specifications is not implied. Exposure to absolute maximum rating conditions for extended periods of time may affect reliability.

Power Supply, (V_{CC}) -0.3V to +6.0V

Input Voltages

DI, DE, \overline{RE} (V_{IH}), High Input Voltage +2V to +6.0V

DI, DE, \overline{RE} (V_{IL}), Low Input Voltage 0V to +0.8V

Differential Input Voltage, (V_{ID}) -12V to +12V

A, B (V_I) +12V to -7V

Output Voltages

RO -0.3V to ($V_{CC} + 0.3V$)

Y, Z (A & B on ZT485) +12V to -7V

Operating Temperature -40°C to +85°C

Storage Temperature -65°C to +150°C

Power Dissipation Per Package

8-pin PDIP (derate 9.09mW/°C above +70°C) 722mW

8-pin nSOIC (derate 6.14mW/°C above +70°C) 500mW

14-pin PDIP (derate 10.00mW/°C above +70°C) 800mW

14-pin nSOIC (derate 8.33mW/°C above +70°C) 667mW

Storage Considerations

Storage in a low humidity environment is preferred. Large high density plastic packages are moisture sensitive and should be stored in Dry Vapor Barrier Bags. Prior to usage, the parts should remain bagged and stored below 40°C and 60%RH. If the parts are removed from the bag, they should be used within 48 hours or stored in an environment at or below 20%RH. If the above conditions cannot be followed, the parts should be baked for four hours at 125°C in order to remove moisture prior to soldering. Zywyn ships product in Dry Vapor Barrier Bags with a humidity indicator card and desiccant pack. The humidity indicator should be below 30%RH.

The information furnished by Zywyn has been carefully reviewed for accuracy and reliability. Its application or use, however, is solely the responsibility of the user. No responsibility of the use of this information become part of the terms and conditions of any subsequent sales agreement with Zywyn. Specifications are subject to change without the responsibility for any infringement of patents or other rights of third parties which may result from its use. No license or proprietary rights are granted by implication or otherwise under any patent or patent rights of Zywyn Corporation.

DC Electrical Characteristics

Unless otherwise stated, $V_{CC} = +5.0V$, $T_A = T_{min}$ to T_{max} , typical values apply at $V_{CC} = +5.0V$ and $T_A = 25^\circ C$.

Parameter	Condition	Min	Typ	Max	Units
TTL Logic Input TTL Logic Output RS-485 Input RS-485 Output Power Pin	DE, DI, \overline{RE} RO A, B Y, Z V_{CC} , V_{GND}	High $Z_{O/P}$ when disabled High $Z_{O/P}$ when disabled			
Temp $0^\circ C$ to $+70^\circ C$ Temp $-40^\circ C$ to $+85^\circ C$ V_{CC} Voltage Range	Commercial Grade Industrial Grade $V_{CC} = +5.0V$ Supply	0 -40 4.75	+25 +25 5.0	+70 +85 5.25	$^\circ C$ $^\circ C$ V
Supply Current I_{CC} , Tx and Rx active I_{CC} , Tx active I_{CC} , Rx active I_{SD} , Shutdown Current	$DI = V_{CC}/GND$, $DE = V_{CC}$, $\overline{RE} = GND$, RS-485 I/P=Open $DI = V_{CC}/GND$, $DE = V_{CC}$, $\overline{RE} = V_{CC}$, RS-485 I/P=Open $DI = V_{CC}/GND$, $DE = GND$, $\overline{RE} = GND$, RS-485 I/P=Open $DI = V_{CC}/GND$, $DE = GND$, $\overline{RE} = V_{CC}$, RS-485 I/P=Open		400 400 400 1.0	1000 1000 1000 10	μA μA μA μA
TTL LOGIC Input Input Threshold Low Input Threshold High	$V_{CC} = +5.0V$ Supply, DE, DI, and \overline{RE} $V_{CC} = +5.0V$ Supply, DE, DI, and \overline{RE}	2.0		0.8	V V
TTL LOGIC Output Output Voltage Low Output Voltage High Output Leakage Current Short Circuit Current	$I_{OUT} = +4mA$, Input Differential Voltage = 200mV $I_{OUT} = -4mA$, Input Differential Voltage = 200mV Receiver Outputs Disabled, $V_{OUT} = 0.4V$ to 2.4V $V_{OUT} = 0V$ to V_{CC}	3.5 7		0.4 ± 1 95	V V μA mA
Receiver Input Input Current Differential Threshold Voltage, V_{TH} Input Hysteresis Input Resistance, R_{IN}	$DE = 0V$, $V_{CC} = 0V$ to 5.25V, $V_{IN} = +12V$ $DE = 0V$, $V_{CC} = 0V$ to 5.25V, $V_{IN} = -7V$ $V_{CM} = -7V$ to +12V, $V_{CC} = +5.0V$, $T_A = 25^\circ C$ $V_{CM} = 0V$ $V_{CM} = -7V$ to +12V	-0.2 12	20	1.0 -0.8 +0.2	mA mA V mV k Ω
Transmitter Output Differential Output Voltage, V_{OD} Differential Output Voltage, dV_{OD} Driver Common Mode Output Change in Voltage Magnitude for Complimentary States, dV_{OC} Change in Voltage Magnitude for Complimentary States, V_{OC} Transmitter Short-Circuit Current	No Load With $R_L = 50\Omega$, $C_L = 50pF$. Refers to figure 1. (RS422) With $R_L = 27\Omega$, $C_L = 50pF$. Refers to figure 1. (RS485) With $R_L = 27\Omega$ or 50Ω , $C_L = 50pF$. Refers to figure 3. Differential Output Voltage, with $R_L = 27\Omega$ or 50Ω , $C_L = 50pF$. Refers to figure 1. Common-Mode Output Voltage, with $R_L = 60\Omega$, 375Ω , 375Ω . Refers to figure 2. Output HIGH, $V_{OUT} = -7V$ to +12V. Refers to figure 7. Output LOW, $V_{OUT} = -7V$ to +12V. Refers to figure 7.	2 1.5		5 5 3 0.2 0.2 250 250	V V V V V mA mA

AC Electrical Characteristics (ZT485E, ZT490E, and ZT491E)

Unless otherwise stated, $V_{CC} = +5.0V$, $T_A = T_{min}$ to T_{max} , typical values apply at $V_{CC} = +5.0V$ and $T_A = 25^\circ C$.

Parameter	Condition	Min	Typ	Max	Units
Transmitter Timing					
Transmitter Propagation t_{PLH}	$R_{DIFF} = 54\Omega$, $C_L = 50pF$, Refers to figure 4.		35	60	ns
Transmitter Propagation t_{PHL}	$R_{DIFF} = 54\Omega$, $C_L = 50pF$, Refers to figure 4.		35	60	ns
Transmitter Output Skew t_{SK}	$ t_{PLH} - t_{PHL} $		3	10	ns
Transmitter Rise/Fall Time	t_R, t_f , $R_{DIFF} = 54\Omega$, $C_L = 50pF$, ZT485E. Refers to figure 4.		15	25	ns
	t_R, t_f , $R_{DIFF} = 54\Omega$, $C_L = 50pF$, ZT490E and ZT491E, refer fig.4.		15	25	ns
Transmitter Output Enable	To Output HIGH, $C_L = 50pF$, $R_L = 110W$. Refers to figure 5.		50		ns
	To Output LOW, $C_L = 50pF$, $R_L = 110W$. Refers to figure 6.		50		ns
Transmitter Output Disable	From Output HIGH, $C_L = 50pF$, $R_L = 110W$. Refers to figure 5.		50		ns
	From Output LOW, $C_L = 50pF$, $R_L = 110W$. Refers to figure 6.		50		ns
Receiver Timing					
Receiver Propagation t_{PLH}	$C_L = 15pF$, Refers to figure 9.		50	150	ns
Receiver Propagation t_{PHL}	$C_L = 15pF$, Refers to figure 9.		50	150	ns
Differential Receiver Skew t_{SK}	$ t_{PHL} - t_{PLH} $		10		ns
Receiver Output Enable	To Output HIGH, $C_L = 15pF$, Refers to figure 10.		50		ns
	To Output LOW, $C_L = 15pF$, Refers to figure 11.		50		ns
Receiver Output Disable	From Output HIGH, $C_L = 15pF$, Refers to figure 10.		50		ns
	From Output LOW, $C_L = 15pF$, Refers to figure 11.		50		ns
Transceiver Throughput					
Maximum Data Rate	$R_L = 54\Omega$, $C_L = 50pF$, One Transmitter Switching, $T_A = 25^\circ C$	10			Mbps
ESD Tolerance					
ESD HBM	RS-485 Inputs and Outputs		± 15		kV

AC Electrical Characteristics (ZT483E, ZT488E, and ZT489E)

Unless otherwise stated, $V_{CC} = +5.0V$, $T_A = T_{min}$ to T_{max} , typical values apply at $V_{CC} = +5.0V$ and $T_A = 25^\circ C$.

Parameter	Condition	Min	Typ	Max	Units
Transmitter Timing					
Transmitter Propagation t_{PLH}	$R_{DIFF} = 54\Omega$, $C_L = 50pF$, Refers to figure 4.	250	800	2000	ns
Transmitter Propagation t_{PHL}	$R_{DIFF} = 54\Omega$, $C_L = 50pF$, Refers to figure 4.	250	800	2000	ns
Transmitter Output Skew t_{SK}	$ t_{PLH} - t_{PHL} $		20	800	ns
Transmitter Rise/Fall Time	$t_R, t_f, R_{DIFF} = 54\Omega$, $C_L = 50pF$, Refers to figure 4.	250		2000	ns
Transmitter Output Enable	To Output HIGH, $C_L = 50pF$, $R_L = 110W$. Refers to figure 5. To Output LOW, $C_L = 50pF$, $R_L = 110W$. Refers to figure 6.		100		ns
Transmitter Output Disable	From Output HIGH, $C_L = 15pF$, $R_L = 110W$. Refers to figure 5. From Output LOW, $C_L = 15pF$, $R_L = 110W$. Refers to figure 6.		100		ns
Receiver Timing					
Receiver Propagation t_{PLH}	$C_L = 15pF$, Refers to figure 9.	250		2000	ns
Receiver Propagation t_{PHL}	$C_L = 15pF$, Refers to figure 9.	250		2000	ns
Differential Receiver Skew t_{SK}	$ t_{PHL} - t_{PLH} $		10		ns
Receiver Output Enable	To Output HIGH, $C_L = 15pF$, Refers to figure 10. To Output LOW, $C_L = 15pF$, Refers to figure 11.		100		ns
Receiver Output Disable	From Output HIGH, $C_L = 15pF$, Refers to figure 10. From Output LOW, $C_L = 15pF$, Refers to figure 11.		100		ns
Shutdown Timing					
Time to Shutdown	ZT = 483E	50	200	600	ns
Transmitter Enable from SHUTDOWN to Output HIGH	$C_L = 50pF$, $R_L = 110W$. Refers to figure 5.		200		ns
Transmitter Enable from SHUTDOWN to Output LOW	$C_L = 50pF$, $R_L = 110W$. Refers to figure 6.		200		ns
Receiver Enable from SHUTDOWN to Output HIGH	$C_L = 15pF$, $R_L = 1kW$. Refers to figure 12.		200		ns
Receiver Enable from SHUTDOWN to Output LOW	$C_L = 15pF$, $R_L = 1kW$. Refers to figure 12.		200		ns
Transceiver Throughput					
Maximum Data Rate	$R_L = 54\Omega$, $C_L = 50pF$, One Transmitter Switching, $T_A = 25^\circ C$	0.25			Mbps
ESD Tolerance					
ESD HBM	RS-485 Inputs and Outputs		± 15		kV

Pin Description

Pin Numbers			Name	Description
ZT483E/ZT485E	ZT488E/ZT490E	ZT489E/ZT491E		
1	2	2	RO	Receiver Output. If A>B by 200mV, then RO = HIGH; if A<B by 200mV, then RO = LOW
2	n/a	3	RE	Receiver Output Enable. Low active input. RO is high-Z when RE = HIGH
3	n/a	4	DE	Driver Output Enable. The transmitter outputs, Y and Z, are enabled when DE = HIGH. The outputs are high-Z when DE = LOW.
4	3	5	DI	Driver Input. A low on DI forces output Y low and output Z high. A high on DI will bring output Y high and output Z low
5	4	6, 7	GND	Analog Ground
n/a	5	9	Y	Non-inverting transmitter output
n/a	6	10	Z	Inverting transmitter output
6	n/a	n/a	A	Non-inverting transmitter output and non-inverting receiver input.
n/a	8	12	A	Non-inverting receiver input.
7	n/a	n/a	B	Inverting transmitter output and inverting receiver input.
n/a	7	11	B	Inverting receiver input
8	1	14	V _{CC}	Power Supply Input, +5V ±5%
n/a	n/a	1, 8, 13	NC	No Connect, Not internally connected

Circuit Description

The ZT483E, ZT485E, ZT489E, ZT490E, and ZT491E are low-power transceivers for RS-485 and RS-422 communications. The RS-485 standard is ideal for multi-drop applications and for long-distance interfaces. The TIA/EIA-485 specification allows up to 32 drivers and 32 receivers to be connected to a data bus, making it an ideal choice for multi-drop applications. RS-485 transceivers are equipped with a wide (-7V to +12V) common mode range to accommodate ground potential differences since the cabling can be as long as 4,000 feet. As RS-485 is a differential interface, data is virtually immune to noise in the transmission line.

The ZT483E, ZT488E, and ZT489E are slew-rate limited, minimizing EMI and reducing reflections caused by improperly terminated cables.

RS-485 Transmitters

Each device in the ZT4xxE family contains a differential output line transmitter that can drive voltage into multiple loads on a terminated two-wire pair, and a receiver that accepts a differential voltage down to 200mV. The transmitter's differential output can comply with RS-485 and also RS-422 standards. The typical voltage output swing with no load is 0V to V_{CC} . With worst case loading of 54 ohms across the differential outputs, the drivers can maintain greater than 1.5V voltage levels, which is more than adequate for a differential receiver to acknowledge a logic state. The 54 ohms is the equivalent of two 120 ohm termination resistors placed on each side of the transmission line and the input impedance of 32 receivers on the line.

The ZT485E transmitter has an enable control line which is active HIGH. A logic HIGH on DE (pin 3) will enable the differential outputs. A logic LOW on DE (pin 3) will disable the transmitter outputs. While disabled, the transmitter outputs are in high impedance.

RS-485 Receivers

Each transceiver contains one differential receiver that has an input sensitivity of 200mV. The input impedance of the receivers is typically 15 kohms. A wide common mode range of -7V to +12V allows for large ground potential differences between systems.

The ZT485E, ZT489E, and ZT491E receivers have an enable control input. A logic LOW on \overline{RE} will enable the receiver, a logic HIGH on \overline{RE} will disable the receiver. The receivers are equipped with the fail-safe feature, which guarantees that the receiver output will be in a HIGH state when the input is left unconnected. This applies for both cases where the receiver inputs are either shorted or open.

The ZT485E, ZT490E, and ZT491E can transmit and receive at data rates up to 10Mbps. The ZT483E, ZT488E, and ZT489E are specified for data rates up to 250kbps.

Bus Configuration

The ZT489E, ZT490E, and ZT491E are full-duplex transceivers, while the ZT483E and ZT485E are half-duplex.

For full duplex, the devices are used as a four-wire bus transceiver with a configuration that the transmitters and receivers are moving data independent of each other. Transmit can occur on a dedicated two-wire pair and receive can occur on an adjacent two-wire pair, with each pair transferring data at up to 10Mbps (up to 250kbps for the ZT489E).

Half duplex is a configuration where the transmitter outputs are connected to its receiver inputs. This application is common for two-wire interfaces where either the transmitter is active or the receiver is active. It is common to connect the enable inputs for the transmitter and receiver together so that a logic HIGH will enable the transmitter and disable the receiver. Conversely, a logic LOW will disable the transmitter and enable the receiver. Half-duplex configurations and these devices are designed for bidirectional data transmission on multipoint twisted-pair cables for applications, such as digital motor controllers, remote sensors and terminals, industrial process control, security stations and environmental control systems.

ESD Immunity

Electro-Static Discharge (ESD) is an important factor when implementing a serial port into a system, especially in harsh environmental conditions. These industrial strength devices provide extra protection against ESD and are intended for harsh environments where high-speed data communication is important.

All of the ZT485E family of transceivers incorporate internal protection structures on all pins to protect against ESD charges encountered during handling and assembly. The driver outputs and receiver inputs have extra protection against static electricity as they are directly interfacing to the outside environment. As such, these pins against ESD of $\pm 15kV$ without damage in all states of the transceiver's operation from normal to powered down. After multiple ESD events, Zywyn's ZT485E family of transceivers keep working without latchup. These devices eliminate the need for external transient suppressor diodes and the associated high capacitance loading, allowing reliable high-speed data communications.

The Human Body Model has been the generally accepted ESD testing method for semiconductors. This test is intended to simulate the human body's potential to store electrostatic energy and discharge it to an integrated circuit upon close proximity or contact. This method will test the IC's capability to withstand an ESD transient during normal handling such as in manufacturing areas where the ICs tend to be handled frequently.

Function Table

ZT483E/ZT485E

DRIVER				RECEIVER		
Input DI	Enable DE	Outputs		Differential Inputs $V_{ID} = V_A - V_B$	Enable \overline{RE}	Output RO
		A	B			
H	H	H	L	$V_{ID} \leq -0.2V$	L	L
L	H	L	H	$-0.2V < V_{ID} < +0.2V$	L	U
X	L	Z	Z	$+0.2V \leq V_{ID}$	L	H
Open	H	H	L	X	H	Z
X	Open	Z	Z	X	Open	Z

ZT488E/ZT490E

DRIVER			RECEIVER	
Input DI	Outputs		Differential Inputs $V_{ID} = V_A - V_B$	Output RO
	Y	Z		
H	H	L	$V_{ID} \leq -0.2V$	L
L	L	H	$-0.2V < V_{ID} < +0.2V$	U
X	Z	Z	$+0.2V \leq V_{ID}$	H
Open	H	L	X	Z
X	Z	Z	X	Z

ZT489E/ZT491E

DRIVER				RECEIVER		
Input DI	Enable DE	Outputs		Differential Inputs $V_{ID} = V_A - V_B$	Enable \overline{RE}	Output RO
		Y	Z			
H	H	H	L	$V_{ID} \leq -0.2V$	L	L
L	H	L	H	$-0.2V < V_{ID} < +0.2V$	L	U
X	L	Z	Z	$+0.2V \leq V_{ID}$	L	H
Open	H	H	L	X	H	Z
X	Open	Z	Z	X	Open	Z

Note:

H = High Level; L = Low Level; Z = High Impedance; X = Irrelevant; U = Undertermine State.

Pin Configuration

ZT483E/ZT485E

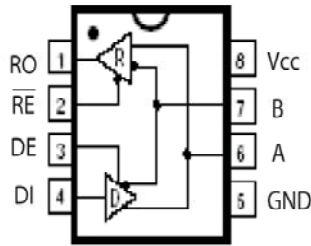

8-Pin PDIP/nSOIC

ZT488E/ZT490E

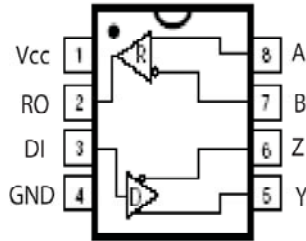

8-Pin PDIP/nSOIC

ZT489E/ZT491E

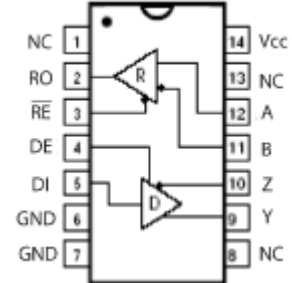

14-Pin PDIP/nSOIC

Typical Application Circuits

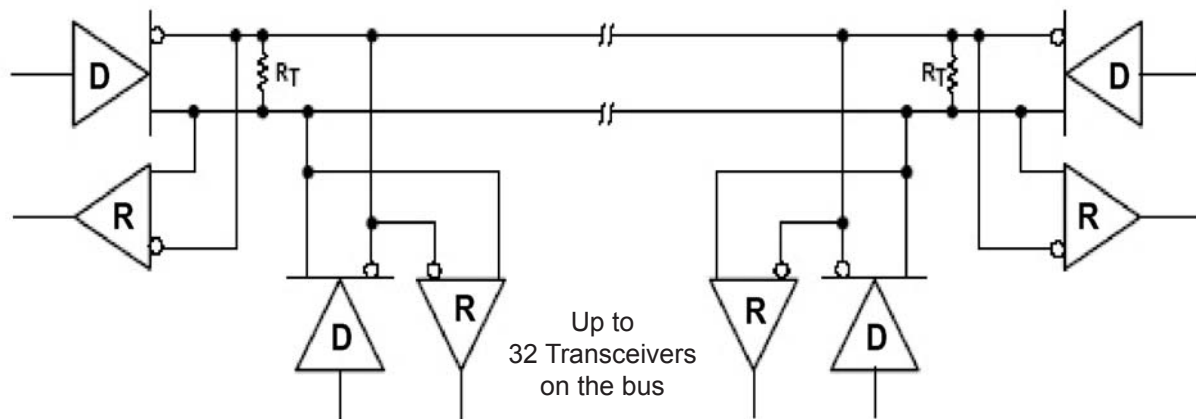

Notes:

- A. The bus should be terminated at both ends in its characteristic impedance of $R_T = Z_O$.
- B. Stub lengths off the main bus should be kept as short as possible.
- C. Can connect up to 32 devices on the same common bus

Typical Test Circuits

Notes:

- A. The test load capacitance includes probe and test jig capacitance, unless otherwise specified.
- B. The signal generator had the following characteristics:
Pulse rate = 1000 kHz, 50% duty cycle, $Z_O = 50\Omega$, t_r & $t_f < 6\text{ns}$, unless otherwise specified.

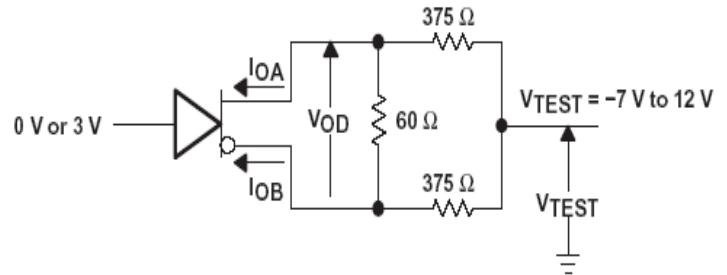
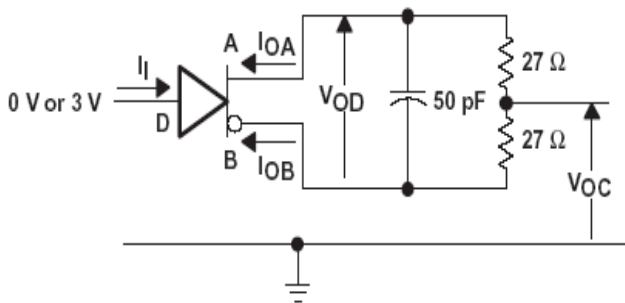

Figure 1. Driver Test Circuit, V_{OD} and V_{OC} Without Common-Mode Loading

Figure 2. Driver Test Circuit, V_{OD} With Common-Mode Loading

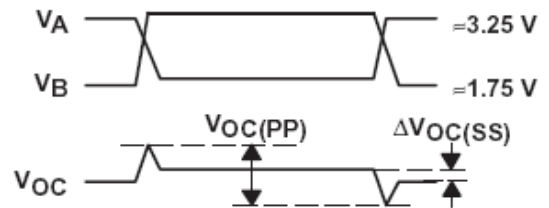
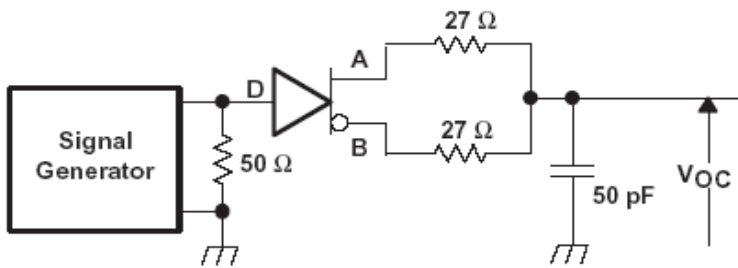

Figure 3. Driver Common-Mode Output Voltage (V_{OC}) Test Circuit and Waveforms

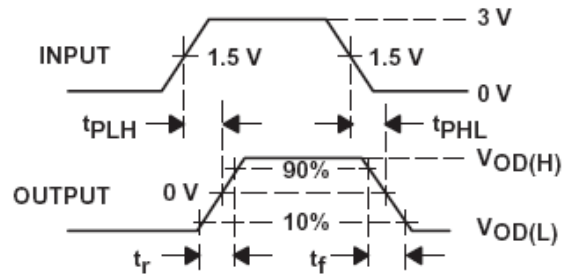
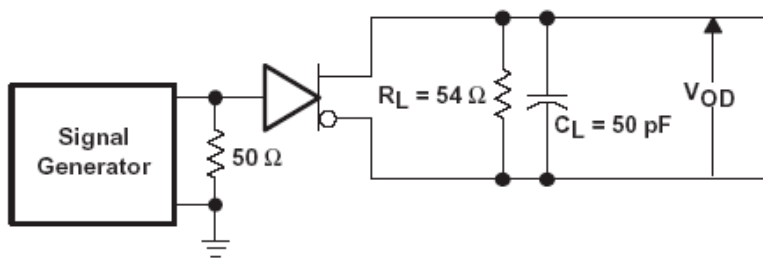

Figure 4. Driver Differential Output Voltage (V_{OD}) Switching Test Circuit and Waveforms

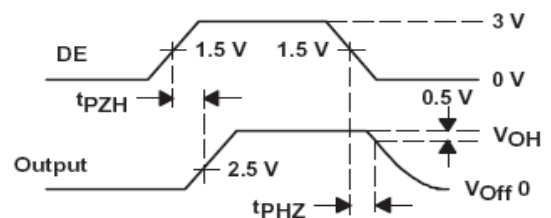
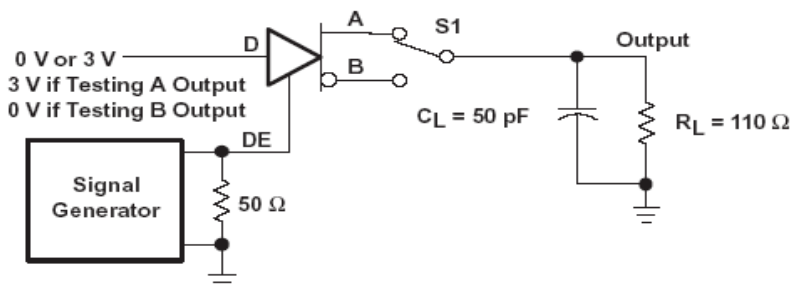

Figure 5. Driver Enable/Disable Test Circuit and Waveforms, High Output

Typical Test Circuits

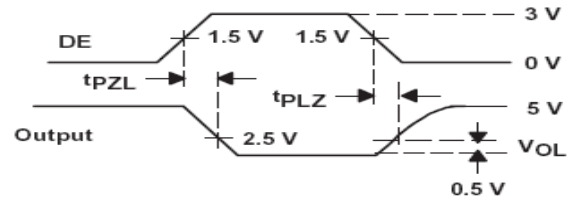
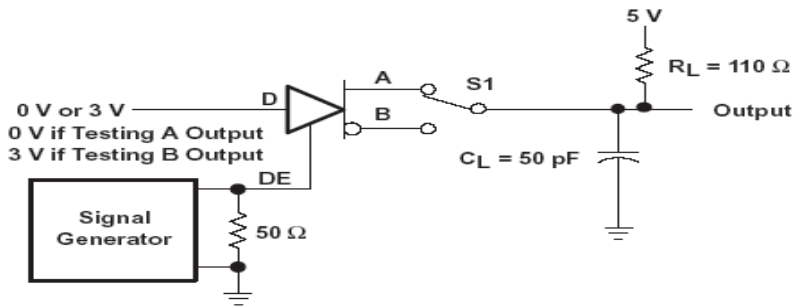

Figure 6. Driver Enable/Disable Test Circuit and Waveforms, Low Output

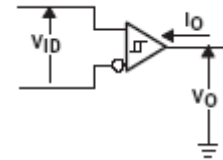
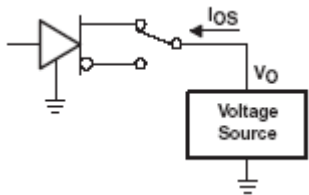

Figure 7. Driver Short-Circuit Test Configuration

Figure 8. Receiver Parameter Definitions

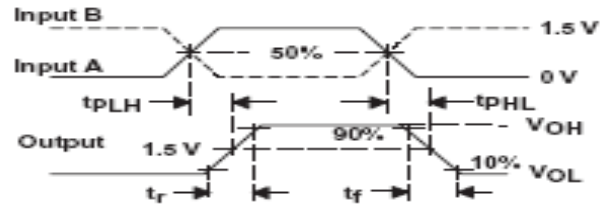
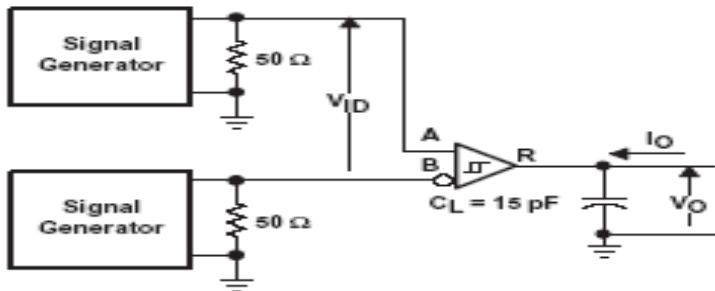

Figure 9. Receiver Propagation (t_{PLH} and t_{PHL}) Test Circuit and Waveforms

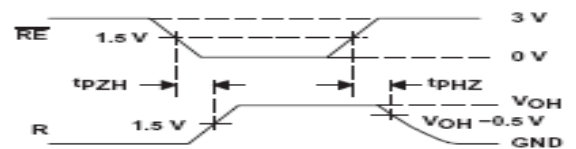
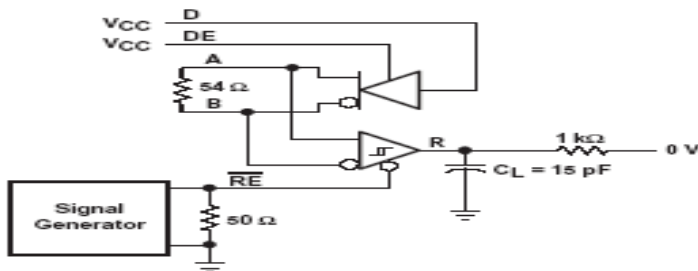

Figure 10. Receiver Output Enable/Disable Test Circuit and Waveforms, Data Output High

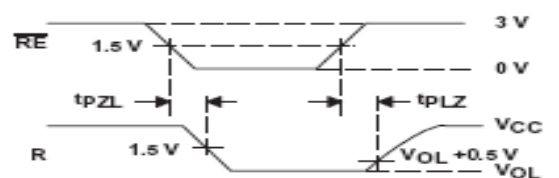
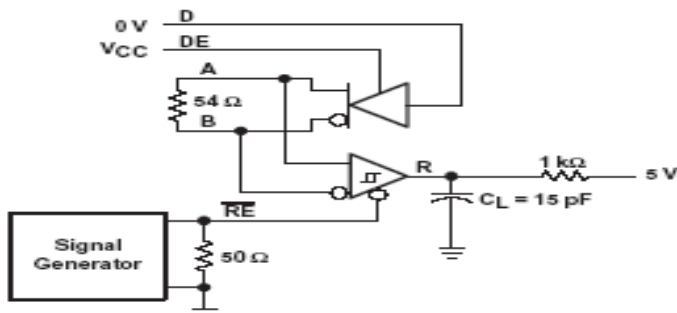
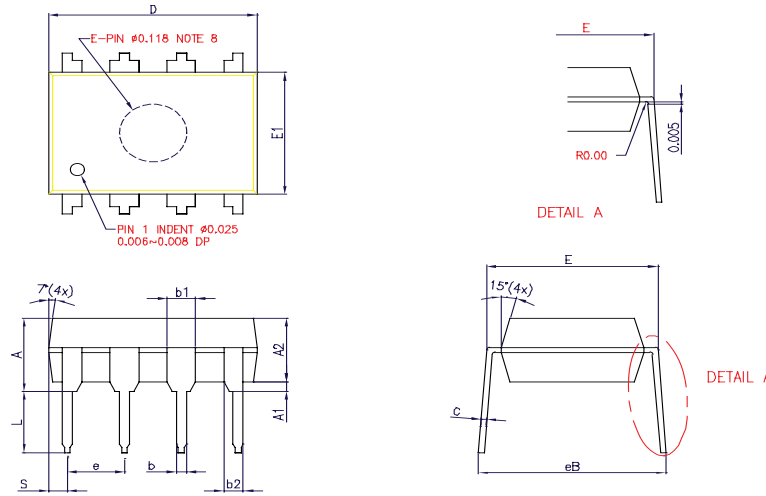

Figure 11. Receiver Output Enable/Disable Test Circuit and Waveforms, Data Output Low

Package Information



- NOTE :
1. CONTROLLING DIMENSION : INCH
 2. LEAD FRAME MATERIAL : C194
 3. DIMENSION D AND E1 DO NOT INCLUDE MOLD FLASH OR PROTRUSIONS. MOLD FLASH OR PROTRUSIONS SHALL NOT EXCEED 0.010" [0.25mm]
 4. DIMENSION "b1" DO NOT INCLUDE DAMBAR PROTRUSION. DAMBAR PROTRUSIONS SHALL NOT EXCEED 0.010" [0.25mm]. DISTANCE BETWEEN LEADS INCLUDING DAMBAR PROTRUSIONS TO BE 0.005" [0.13mm] MINIMUM.
 5. TOLERANCE : ±0.010" [0.25mm] UNLESS OTHERWISE SPECIFIED.
 6. OTHERWISE DIMENSION FOLLOW ACCEPTABLE SPEC.
 7. REFERENCE DOCUMENT : JEDEC SPEC MS-001-BA
 8. BOTTOM E-PIN INDENT ARE MARKED AS BELOW:



X : A ~ T
Y : 0 ~ 9

SYMBOLS	DIMENSIONS IN MILLIMETERS			DIMENSIONS IN INCHES		
	MIN	NOM	MAX	MIN	NOM	MAX
A	3.6	3.9	4.2	0.142	0.154	0.165
A1	0.38	—	—	0.015	—	—
A2	3.25	3.30	3.45	0.128	0.130	0.136
b	0.38	0.48	0.56	0.015	0.019	0.022
b1	1.48	1.58	1.88	0.058	0.062	0.074
b2	0.813	0.99	1.14	0.032	0.039	0.045
C	0.20	0.25	0.30	0.008	0.010	0.012
D	9.12	9.30	9.53	0.359	0.366	0.375
E	7.62	7.87	8.26	0.300	0.310	0.325
E1	6.20	6.35	6.60	0.244	0.250	0.260
e	—	2.54	—	—	0.100	—
eB	8.38	—	9.40	0.330	—	0.370
L	3.18	—	—	0.125	—	—
S	0.71	0.84	0.97	0.028	0.033	0.038

8-pin PDIP

CUSTOMER :		ZYWYN CORPORATION	
APPROVED BY	DATE	TITLE :	
Paul Lau	01/27/00	8L P-DIP PACKAGE OUTLINE DRAWING FOR MITSUMI	
DRAW BY:	DATE	DWG. NO.	REV.
Sandy Liu	01/24/00	PO-DIP-019	0
CHECK BY:	DATE	UNIT :	SCALE :
Leo Chen	01/28/00	INCH	6/1
APPROVAL:	DATE	SHEET 1 OF 1	
Paul Lau	01/27/00		
APPROVAL:	DATE		
Barry Chen	1/27/00		

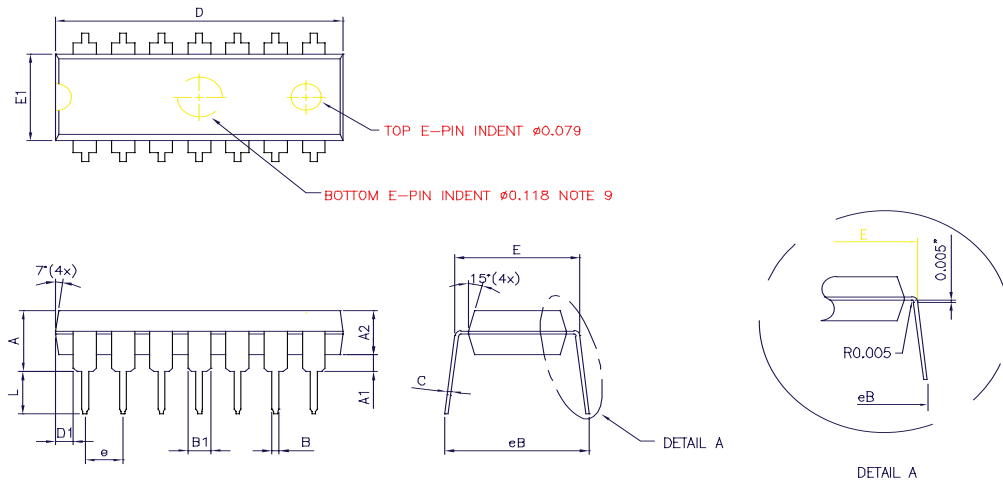

- NOTES :
1. CONTROLLING DIMENSION : INCH
 2. LEAD FRAME MATERIAL MATERIAL : C194
 3. PACKAGE DIMENSION EXCLUDE MOLDING FLASH
 4. AFTER SOLDER PLATING LEAD THICKNESS WILL BE 0.013" MAX
 5. AFTER SOLDER DIPPING LEAD THICKNESS WILL BE 0.020" MAX
 6. THE MAX. ALLOWABLE MOLDING FLASH IS 0.010"
 7. TOLERANCE : 0.002" UNLESS OTHERWISE SPECIFIED
 8. OTHERWISE DIMENSION FOLLOW ACCEPTABLE SPES
 9. THE BOTTOM E- PIN INDENT IS MARKED AS BELOW :



X : A-1
Y : 0-9

SYMBOLS	DIMENSIONS IN MILLIMETERS			DIMENSIONS IN INCHES		
	MIN	NOM	MAX	MIN	NOM	MAX
A	—	—	4.57	—	—	0.180
A1	0.38	—	—	0.015	—	—
A2	3.25	3.30	3.45	0.128	0.130	0.136
B	0.26	0.46	0.56	0.014	0.018	0.022
B1	1.14	1.27	1.52	0.045	0.050	0.060
C	0.20	0.25	0.33	0.008	0.010	0.013
D	18.19	19.15	19.30	0.744	0.754	0.760
D1	0.81	1.19	1.47	0.032	0.047	0.058
E	7.62	—	8.26	0.300	—	0.325
E1	6.35	6.50	6.65	0.250	0.256	0.262
e	—	2.54	—	—	0.100	—
L	3.18	—	—	0.125	—	—
eB	8.63	—	9.65	0.340	—	0.380

14-pin PDIP

CUSTOMER :		ZYWYN CORPORATION	
APPROVED BY	DATE	TITLE :	
Paul Lau	05/12/99	14L P-DIP PACKAGE OUTLINE DRAWING	
DRAW BY:	DATE	DWG. NO.	REV.
Vivi Chen	05/12/99	PO-DIP-002	0
CHECK BY:	DATE	UNIT :	SCALE :
Thomas Kao	5/12/99	INCH	4/1
APPROVAL:	DATE	SHEET 1 OF 1	
Paul Lau	5/12/99		
APPROVAL:	DATE		
Barry Chen	5/12/99		

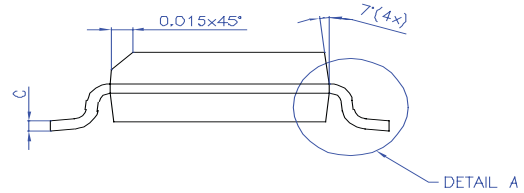
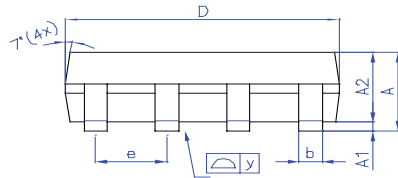
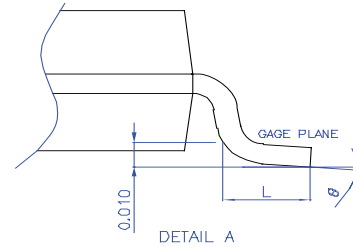
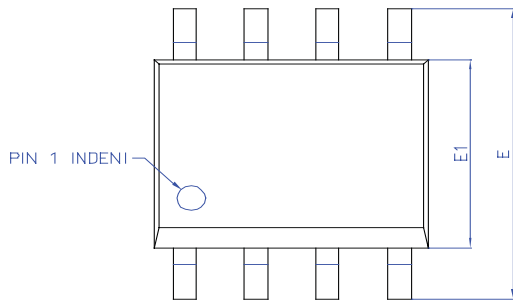

NOTE :

- CONTROLLING DIMENSION - INCH
- LEAD FRAME MATERIAL : COPPER 194
- DIMENSION "D" DOES NOT INCLUDE MOLD FLASH, TIE BAR BURRS AND GATE BURRS. MOLD FLASH, TIE BAR BURRS AND GATE BURRS SHALL NOT EXCEED 0.006[0.15mm] PER END DIMENSION "E1" DOES NOT INCLUDE INTERLEAD FLASH, INTERLEAD FLASH SHALL NOT EXCEED 0.010[0.25mm] PER SIDE.
- DIMENSION "b" DOES NOT INCLUDE DAMBAR PROTRUSION. ALLOWABLE DAMBAR PROTRUSION SHALL BE 0.003[0.08mm] TOTAL IN EXCESS OF THE "b" DIMENSION AT MAXIMUM MATERIAL CONDITION. DAMBAR CANNOT BE LOCATED ON THE LOWER RADIUS OR THE FOOT. MINIMUM SPACE BETWEEN PROTRUSION AND AN ADJACENT LEAD TO BE 0.0028[0.07mm]
- TOLERANCE : ± 0.010 [0.25mm] UNLESS OTHERWISE SPECIFIED.
- OTHERWISE DIMENSION FOLLOW ACCEPTABLE SPEC.
- REFERENCE DOCUMENT : JEDEC SPEC MS-012

SYMBOLS	DIMENSIONS IN MILLIMETERS			DIMENSIONS IN INCHES		
	MIN	NOM	MAX	MIN	NOM	MAX
A	1.47	1.60	1.73	0.058	0.063	0.068
A1	0.10	—	0.25	0.004	—	0.010
A2	—	1.45	—	—	0.057	—
b	0.33	0.41	0.51	0.013	0.016	0.020
C	0.19	0.20	0.25	0.0075	0.008	0.0098
D	4.80	4.85	4.95	0.189	0.191	0.195
E	5.80	6.00	6.20	0.228	0.236	0.244
E1	3.80	3.90	4.00	0.150	0.154	0.157
e	—	1.27	—	—	0.050	—
Δ L	0.40	0.71	1.27	0.015	0.028	0.050
y	—	—	0.076	—	—	0.003
ϕ	0°	—	8°	0°	—	8°

8-pin nSOIC

CUSTOMER :		ZYWYN CORPORATION	
APPROVED BY	DATE	TITLE:	
DRAW BY: <i>Wai Chen</i>	05/21/01	8L NARROW BODY SMALL OUTLINE PACKAGE DRAWING	
CHECK BY:		DWG. NO.	PO-SOP-001
APPROVAL: <i>Susan Liu</i>	06/01/01	REV.	2
APPROVAL: <i>Drew Faust</i>	06/01/01	UNIT :	INCH
APPROVAL: <i>Drew Faust</i>	06/01/01	SCALE :	15/1
		SHEET	1 OF 1

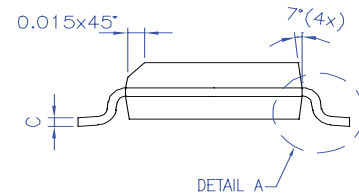
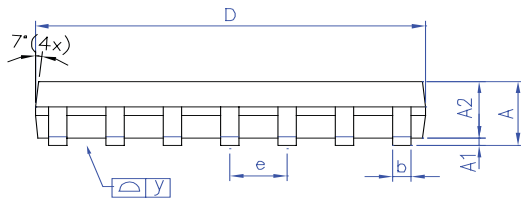
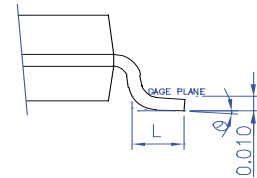
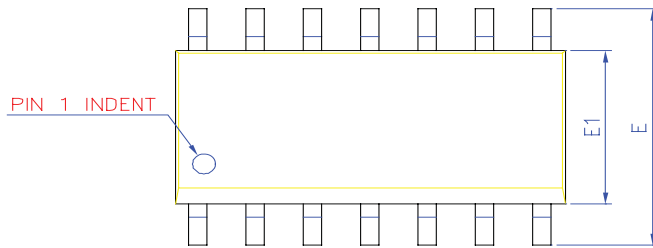

NOTE :













- CONTROLLING DIMENSION : INCH
- LEAD FRAME MATERIAL : COPPER 194
- DIMENSION "D" DOES NOT INCLUDE MOLD FLASH, TIE BAR BURRS AND GATE BURRS. MOLD FLASH, TIE BAR BURRS AND GATE BURRS SHALL NOT EXCEED 0.006[0.15mm] PER END DIMENSION "E1" DOES NOT INCLUDE INTERLEAD FLASH, INTERLEAD FLASH SHALL NOT EXCEED 0.010[0.25mm] PER SIDE.
- DIMENSION "b" DOES NOT INCLUDE DAMBAR PROTRUSION. ALLOWABLE DAMBAR PROTRUSION SHALL BE 0.003[0.08mm] TOTAL IN EXCESS OF THE "b" DIMENSION AT MAXIMUM MATERIAL CONDITION. DAMBAR CANNOT BE LOCATED ON THE LOWER RADIUS OR THE FOOT. MINIMUM SPACE BETWEEN PROTRUSION AND AN ADJACENT LEAD TO BE 0.0028[0.07mm]
- TOLERANCE : ± 0.010 [0.25mm] UNLESS OTHERWISE SPECIFIED.
- OTHERWISE DIMENSION FOLLOW ACCEPTABLE SPEC.
- REFERENCE DOCUMENT : JEDEC SPEC MS-012

SYMBOLS	DIMENSIONS IN MILLIMETERS			DIMENSIONS IN INCHES		
	MIN	NOM	MAX	MIN	NOM	MAX
A	1.47	1.60	1.73	0.058	0.063	0.068
A1	0.10	—	0.25	0.004	—	0.010
A2	—	1.45	—	—	0.057	—
b	0.33	0.41	0.51	0.013	0.016	0.020
C	0.19	0.20	0.25	0.0075	0.008	0.0098
D	8.53	8.64	8.74	0.336	0.340	0.344
E	5.79	5.99	6.20	0.228	0.236	0.244
E1	3.81	3.91	3.99	0.150	0.154	0.157
e	—	1.27	—	—	0.050	—
Δ L	0.40	0.71	1.27	0.016	0.028	0.050
y	—	—	0.076	—	—	0.003
ϕ	0°	—	8°	0°	—	8°

14-pin nSOIC

CUSTOMER :		ZYWYN CORPORATION	
APPROVED BY	DATE	TITLE:	
DRAW BY: <i>Sandy Sue</i>	01/07/04	14L NARROW BODY SMALL OUTLINE PACKAGE DRAWING	
CHECK BY:		DWG. NO.	PO-SOP-002
APPROVAL: <i>Susan Liu</i>	01/07/04	REV.	1
APPROVAL: <i>Parker Chen</i>	01/07/04	UNIT :	INCH
APPROVAL: <i>Andy Yang</i>	01/07/04	SCALE :	12/1
		SHEET	1 OF 1

Ordering Information

Part Number	Temperature Range	Package Type	Green Package
ZT483ECN	0°C to +70°C	8-pin nSOIC	
ZT483ECP	0°C to +70°C	8-pin PDIP	
ZT485ECN	0°C to +70°C	8-pin nSOIC	
ZT485ECP	0°C to +70°C	8-pin PDIP	
ZT488ECN	0°C to +70°C	8-pin nSOIC	
ZT488ECP	0°C to +70°C	8-pin PDIP	
ZT489ECN	0°C to +70°C	14-pin nSOIC	
ZT489ECP	0°C to +70°C	14-pin PDIP	
ZT490ECN	0°C to +70°C	8-pin nSOIC	
ZT490ECP	0°C to +70°C	8-pin PDIP	
ZT491ECN	0°C to +70°C	14-pin nSOIC	
ZT491ECP	0°C to +70°C	14-pin PDIP	
ZT483EEN	-40°C to +85°C	8-pin nSOIC	ZT483LEEN 
ZT483EEP	-40°C to +85°C	8-pin PDIP	ZT483LEEP 
ZT485EEN	-40°C to +85°C	8-pin nSOIC	ZT485LEEN 
ZT485EEP	-40°C to +85°C	8-pin PDIP	ZT485LEEP 
ZT488EEN	-40°C to +85°C	8-pin nSOIC	ZT488LEEN 
ZT488EEP	-40°C to +85°C	8-pin PDIP	ZT488LEEP 
ZT489EEN	-40°C to +85°C	14-pin nSOIC	ZT489LEEN 
ZT489EEP	-40°C to +85°C	14-pin PDIP	ZT489LEEP 
ZT490EEN	-40°C to +85°C	8-pin nSOIC	ZT490LEEN 
ZT490EEP	-40°C to +85°C	8-pin PDIP	ZT490LEEP 
ZT491EEN	-40°C to +85°C	14-pin nSOIC	ZT491LEEN 
ZT491EEP	-40°C to +85°C	14-pin PDIP	ZT491LEEP 

Please contact the factory for pricing, availability on Tape-on-Reel, and **Green Package**  options.

Part Marking Information

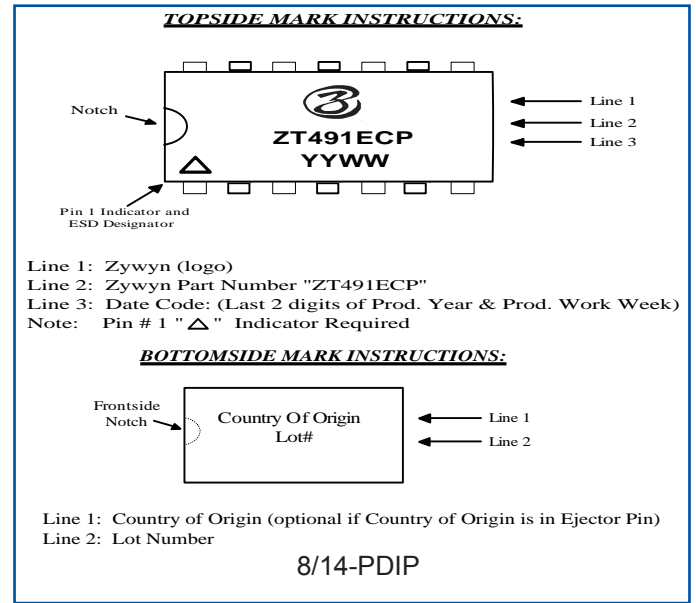
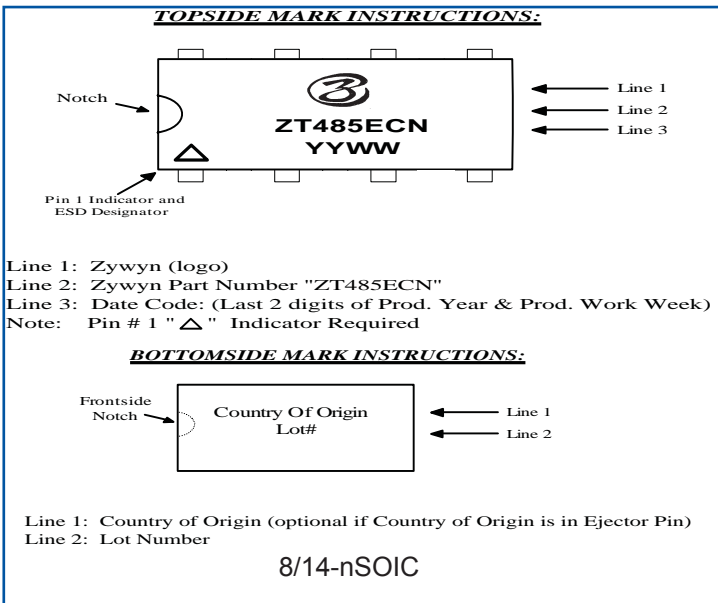

Zywyn Corporation

Headquarters and Sales Office

1270 Oakmead Parkway, Suite 201 • Sunnyvale, CA 94085 • Tel: (408) 733-3225 • Fax: (408) 733-3206

Email: sales@zywyn.com • www.zywyn.com

Zywyn Corporation reserves the right to make changes to any products described herein. Zywyn does not assume any liability arising out of the application or use of any product or circuit described herein; neither does it convey any license under its patent rights nor the rights of others.

© 2005 Zywyn Corporation



Specifications subject to change without notice